



Join the TUM family and wear the exclusive Christmas TUM *Staticap*! one size fits all ...

With all the best wishes for Christmas 2023 and the new year 2024. Stay save.

Your Lehrstuhl für Statik.

And this is how it works:

1. Cut out all parts A-E.
2. Part B: Cut the flaps and fold them upwards.
3. Turn A upside down and glue it to B from below.
4. Glue D and E to C.
5. Glue the flaps of B to C from the inside.
6. Thread the narrow end of E through slot 1 of D.
7. Adjust the size to your head, fold the narrow end and put it back into slot 2 of D. Eventually glue the parts.
8. Click to watch the trailer: <https://youtu.be/15wZt5PESqE>

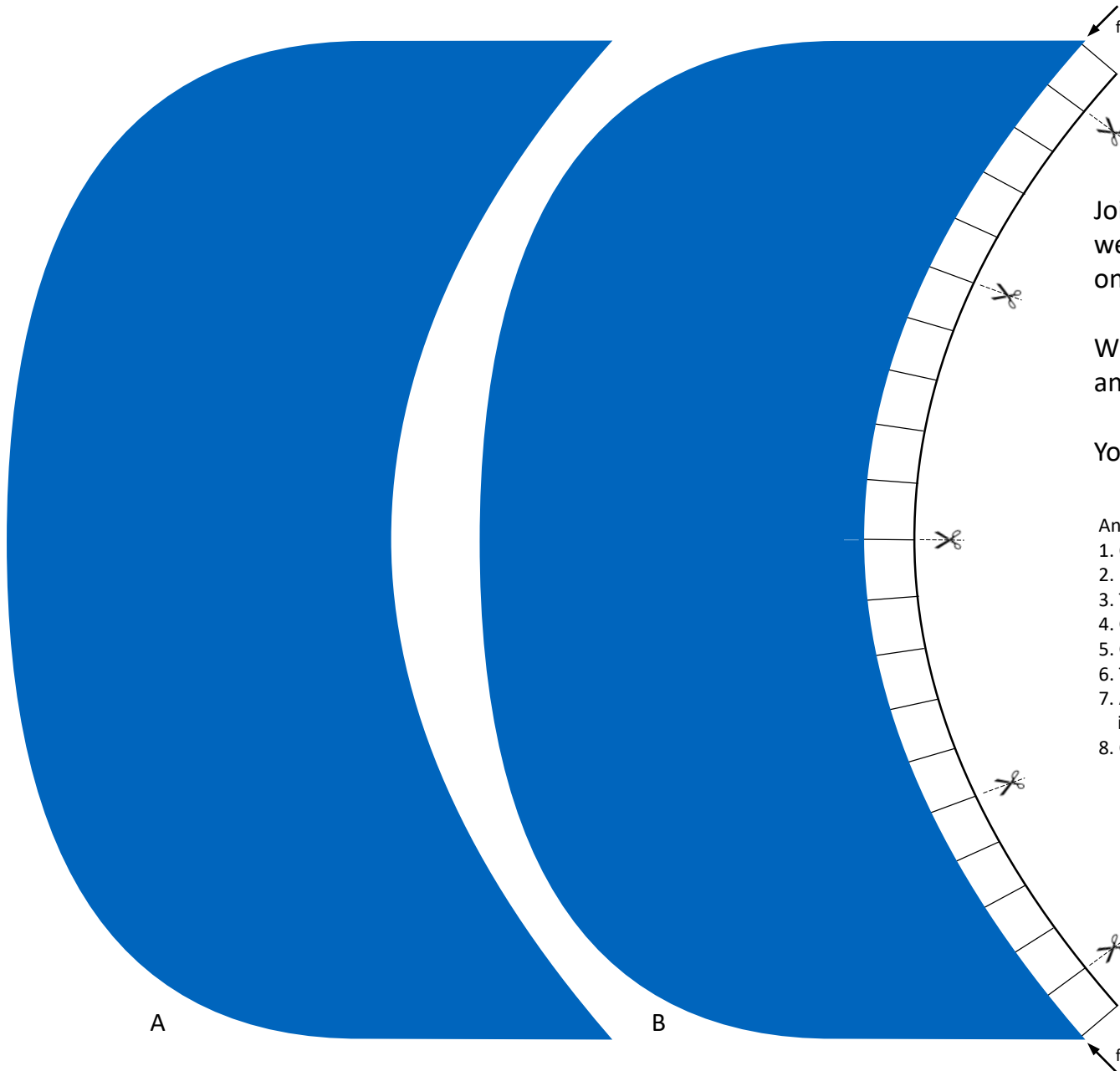
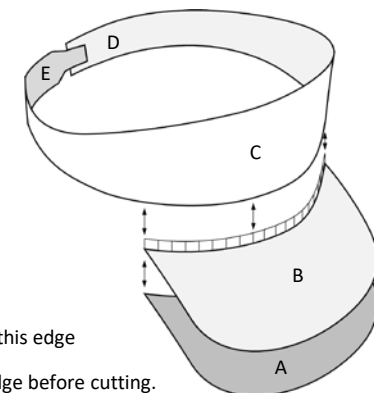

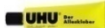
**You still need:** scissors and glue. The classic UHU all-purpose glue is ideal. 

**Hint:** Score the folded edge before cutting.

# The official one

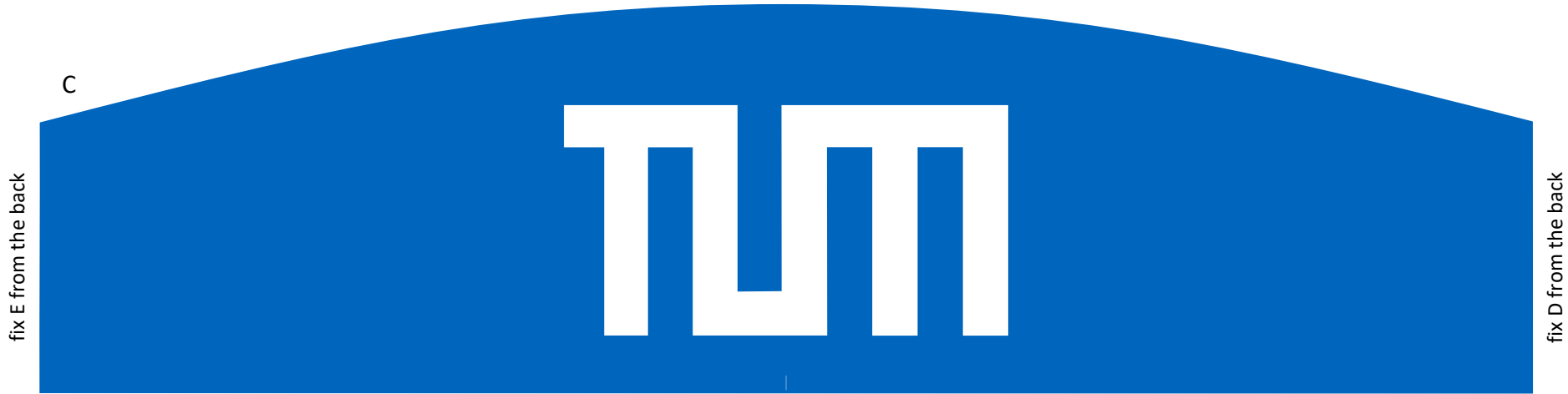

You still need: scissors and glue. The classic UHU all-purpose glue is ideal.



They know to wear it! Try the special Christmas edition!





snapback



trucker



under armour



sommer



clipart



louis vuitton



new era



**Hot Choice** Staticlaus Cap: Unisex Retro Applique, Distressed, Snapback

One size fits all, Adjustable headband, foldable.  
Smallest possible carbon foot kick to your head. Sustainable, recyclable.

only excited comments:

*very very very very good  
exciting, exceptional, the greatest ever  
great hat, exactly like picture  
fantastic quality, super craftsmanship  
really good fit, I like the used look  
looks authentically worn and well used, exactly what I wanted  
what I've always dreamed of*

★★★★★ (100.000)

Our further articles (more in stock, visit our on-line store)



special Christmas offer!!!

Lucia at her brightest  
washed, artistic embroidery  
only 9 left  
★★★★★ (90.000)



special Christmas offer!!!

The original Staticap  
Casual unisex cap, cool  
only 23 left  
★★★★★ (70.000)



special Christmas offer!!!

KingTUM of Bavaria  
Letter Mbroidery washed  
only 7 left  
★★★★★ (120.000)



special Christmas offer!!!

Staticcaptain (on order only)  
Allweather, storm proofed  
only 17 left  
★★★★★ (60.000)



special Christmas offer!!!

Staticop (on order only)  
Distressed denim Sport cap  
only 4 left  
★★★★★ (60.000)



Join the TUM family and wear the exclusive Christmas TUM *Staticap!* one size fits all ...

With all the best wishes for Christmas 2023 and the new year 2024. Stay save.

Your Lehrstuhl für Statik.

And this is how it works:

1. Cut out all parts A-E.
2. Part B: Cut the flaps and fold them upwards.
3. Turn A upside down and glue it to B from below.
4. Glue D and E to C.
5. Glue the flaps of B to C from the inside.
6. Thread the narrow end of E through slot 1 of D.
7. Adjust the size to your head, fold the narrow end and put it back into slot 2 of D. Eventually glue the parts.
8. Click to watch the trailer: <https://youtu.be/15wZt5PESqE>

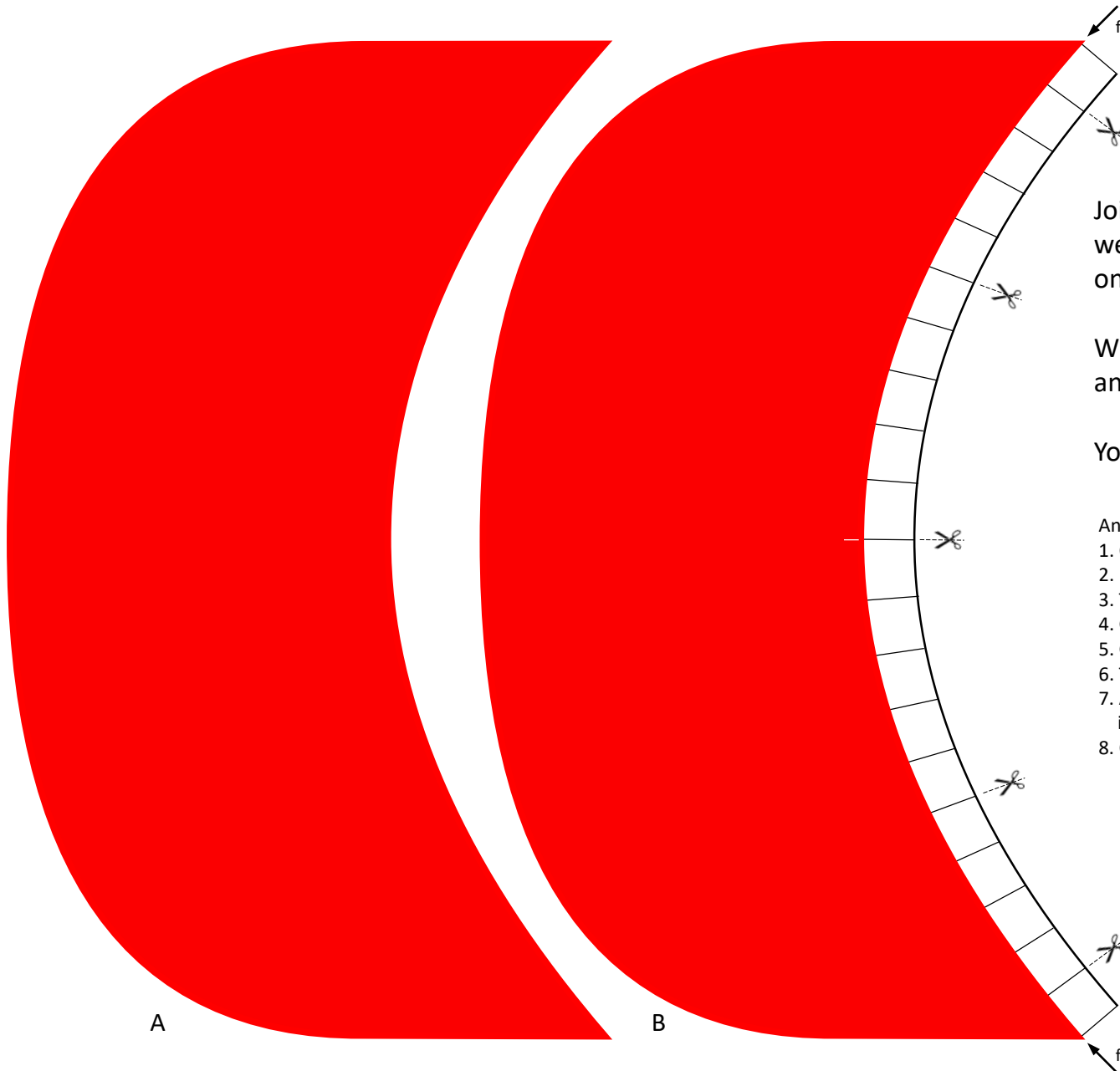
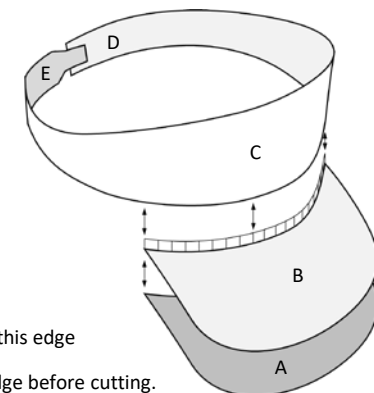

**You still need:** scissors and glue. The classic UHU all-purpose glue is ideal.



**Hint:** Score the folded edge before cutting.

# The Christmas special



You still need: scissors and glue. The classic UHU all-purpose glue is ideal.





Join the TUM family and wear the exclusive Christmas TUM *Staticap!* one size fits all ...

With all the best wishes for Christmas 2023 and the new year 2024. Stay save.

Your Lehrstuhl für Statik.

And this is how it works:

1. Cut out all parts A-E.
2. Part B: Cut the flaps and fold them upwards.
3. Turn A upside down and glue it to B from below.
4. Glue D and E to C.
5. Glue the flaps of B to C from the inside.
6. Thread the narrow end of E through slot 1 of D.
7. Adjust the size to your head, fold the narrow end and put it back into slot 2 of D. Eventually glue the parts.
8. Click to watch the trailer: <https://youtu.be/15wZt5PESqE>

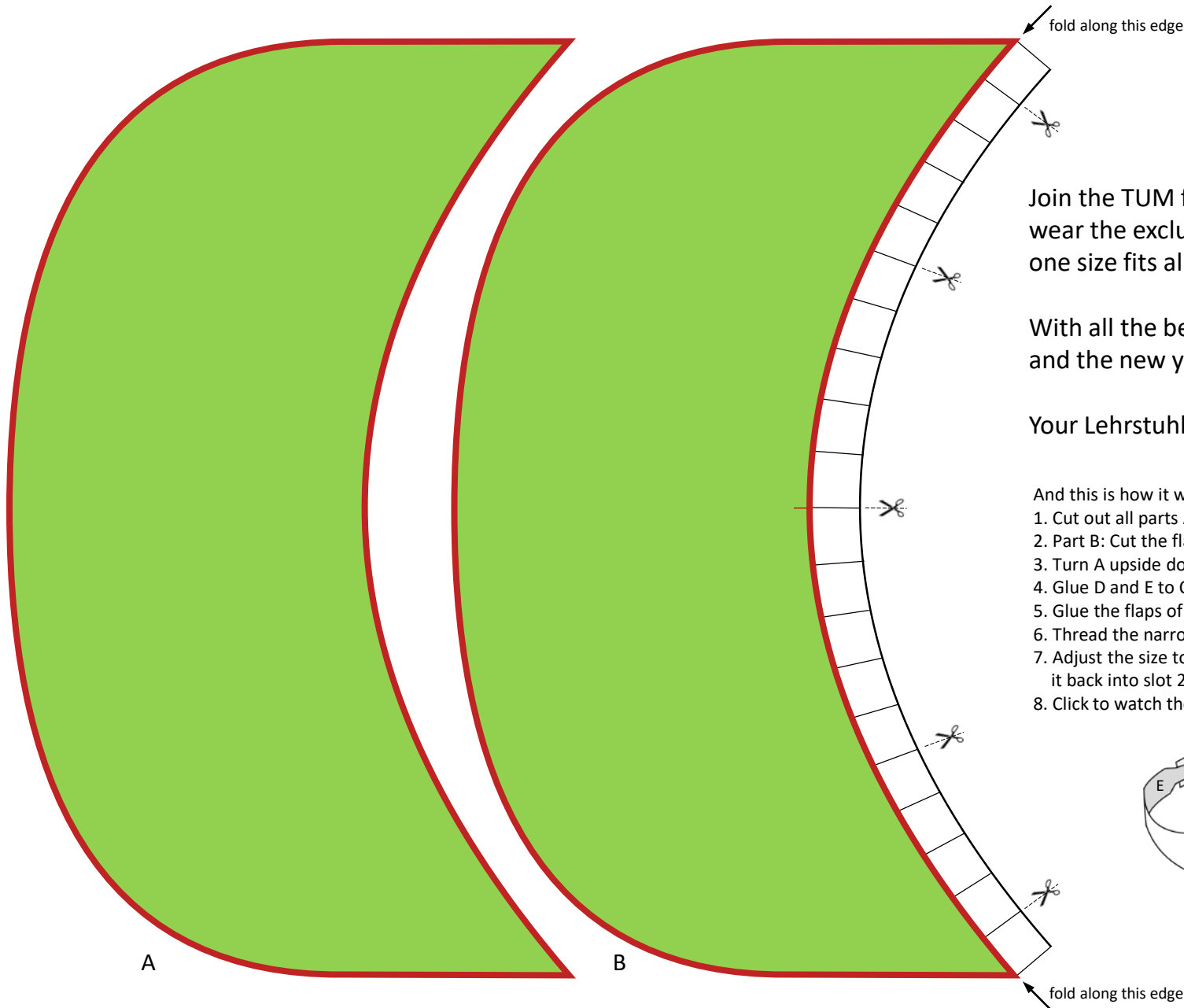
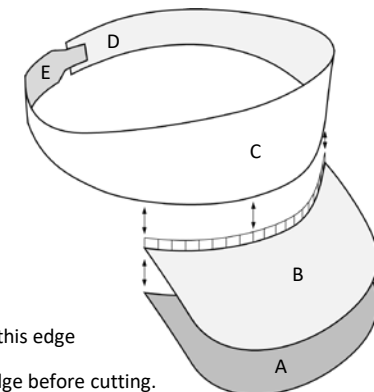

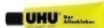
You still need: scissors and glue. The classic UHU all-purpose glue is ideal. 

Hint: Score the folded edge before cutting.

# The Scandinavian

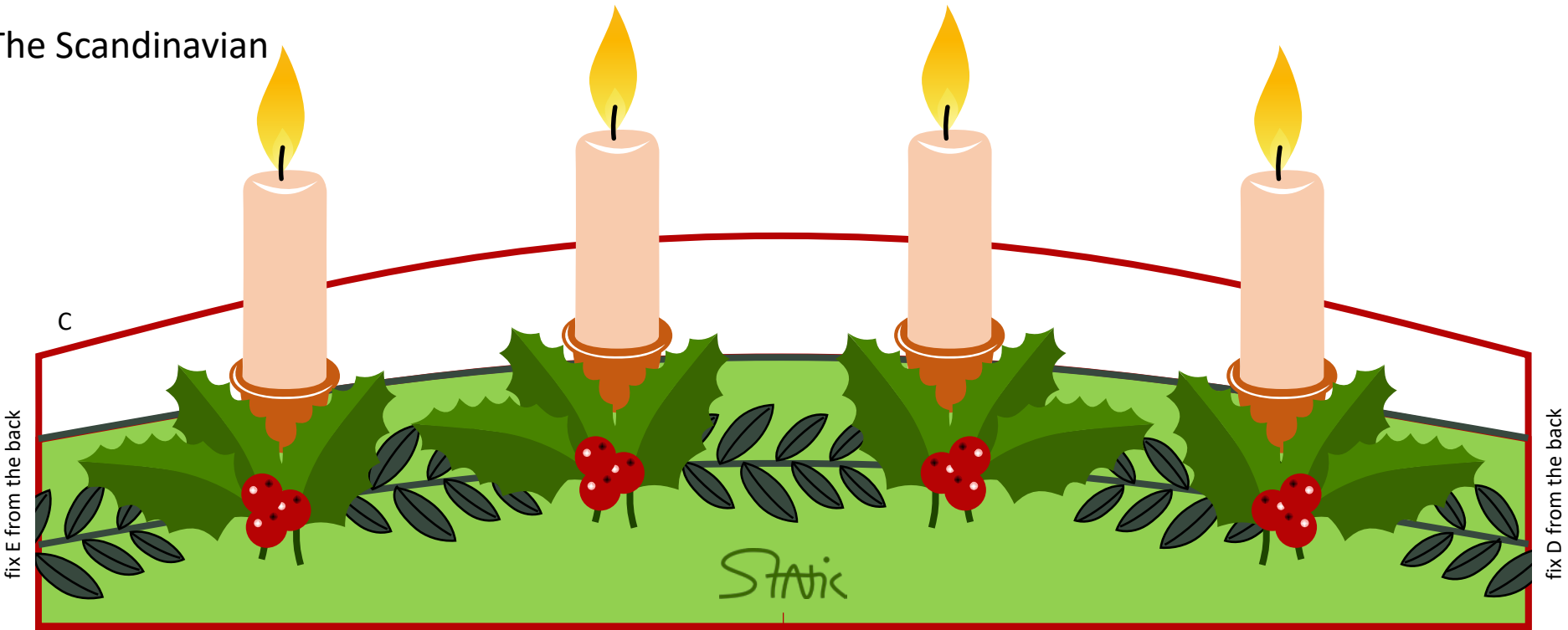

You still need: scissors and glue. The classic UHU all-purpose glue is ideal. 







Join the TUM family and wear the exclusive Christmas TUM *Staticap!* one size fits all ...

With all the best wishes for Christmas 2023 and the new year 2024. Stay save.

Your Lehrstuhl für Statik.

And this is how it works:

1. Cut out all parts A-E.
2. Part B: Cut the flaps and fold them upwards.
3. Turn A upside down and glue it to B from below.
4. Glue D and E to C.
5. Glue the flaps of B to C from the inside.
6. Thread the narrow end of E through slot 1 of D.
7. Adjust the size to your head, fold the narrow end and put it back into slot 2 of D. Eventually glue the parts.
8. Click to watch the trailer: <https://youtu.be/15wZt5PESqE>

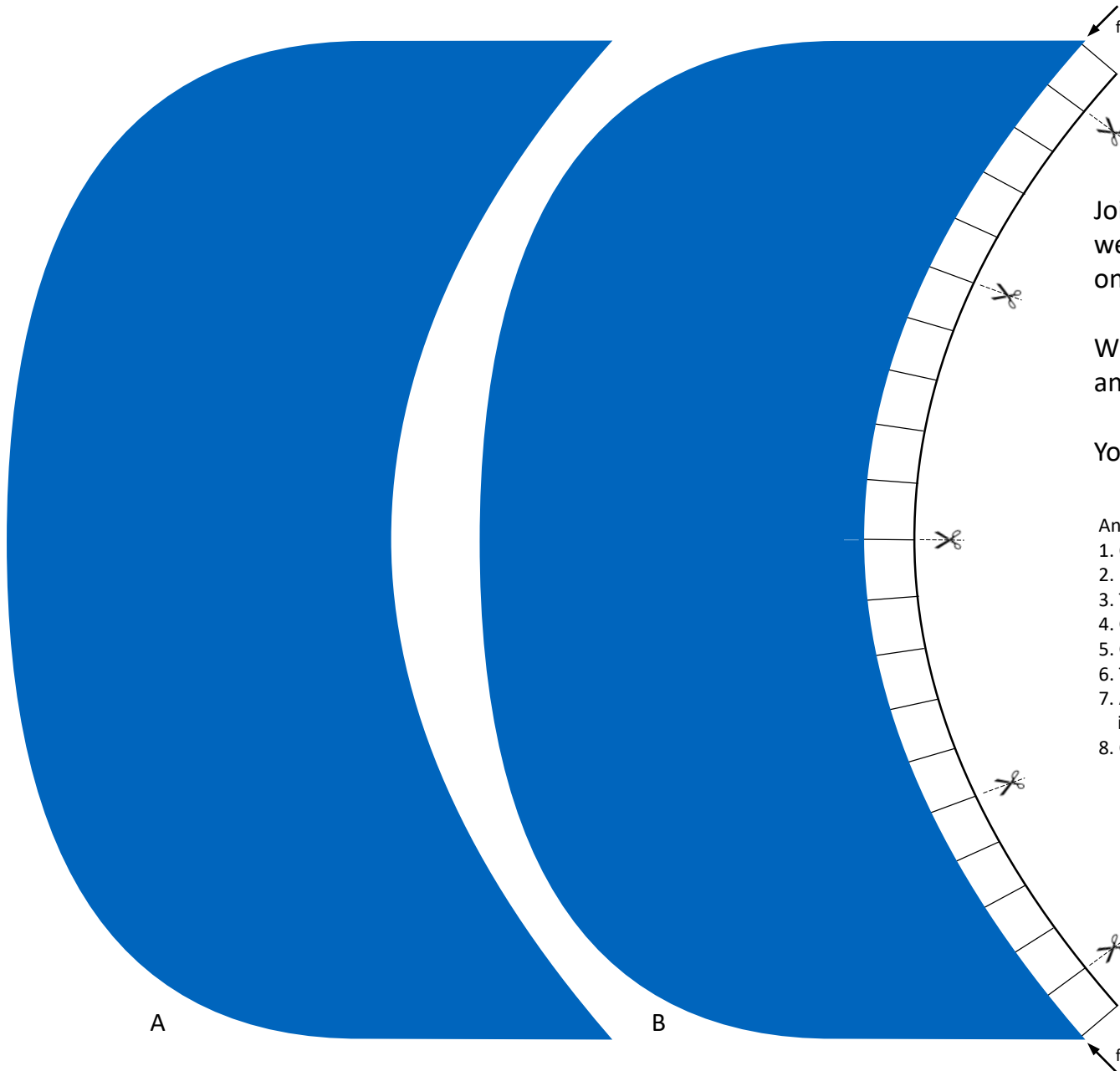
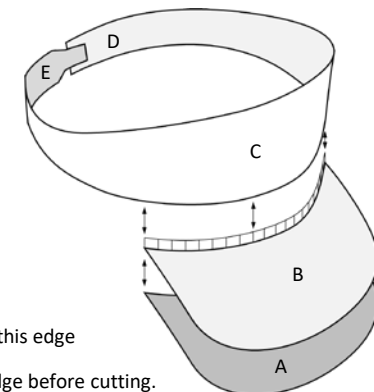

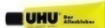
**You still need:** scissors and glue. The classic UHU all-purpose glue is ideal. 

**Hint:** Score the folded edge before cutting.

# The original one



You still need: scissors and glue. The classic UHU all-purpose glue is ideal.

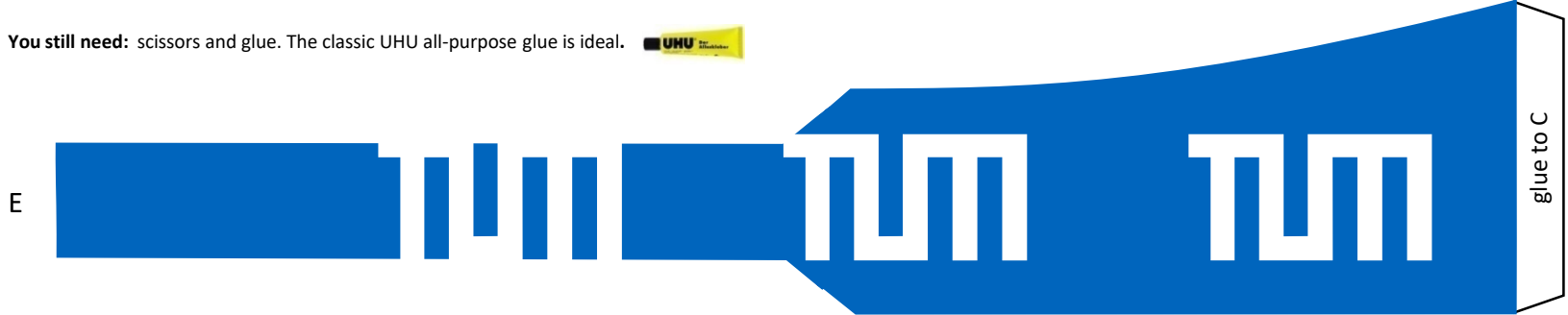

The real one

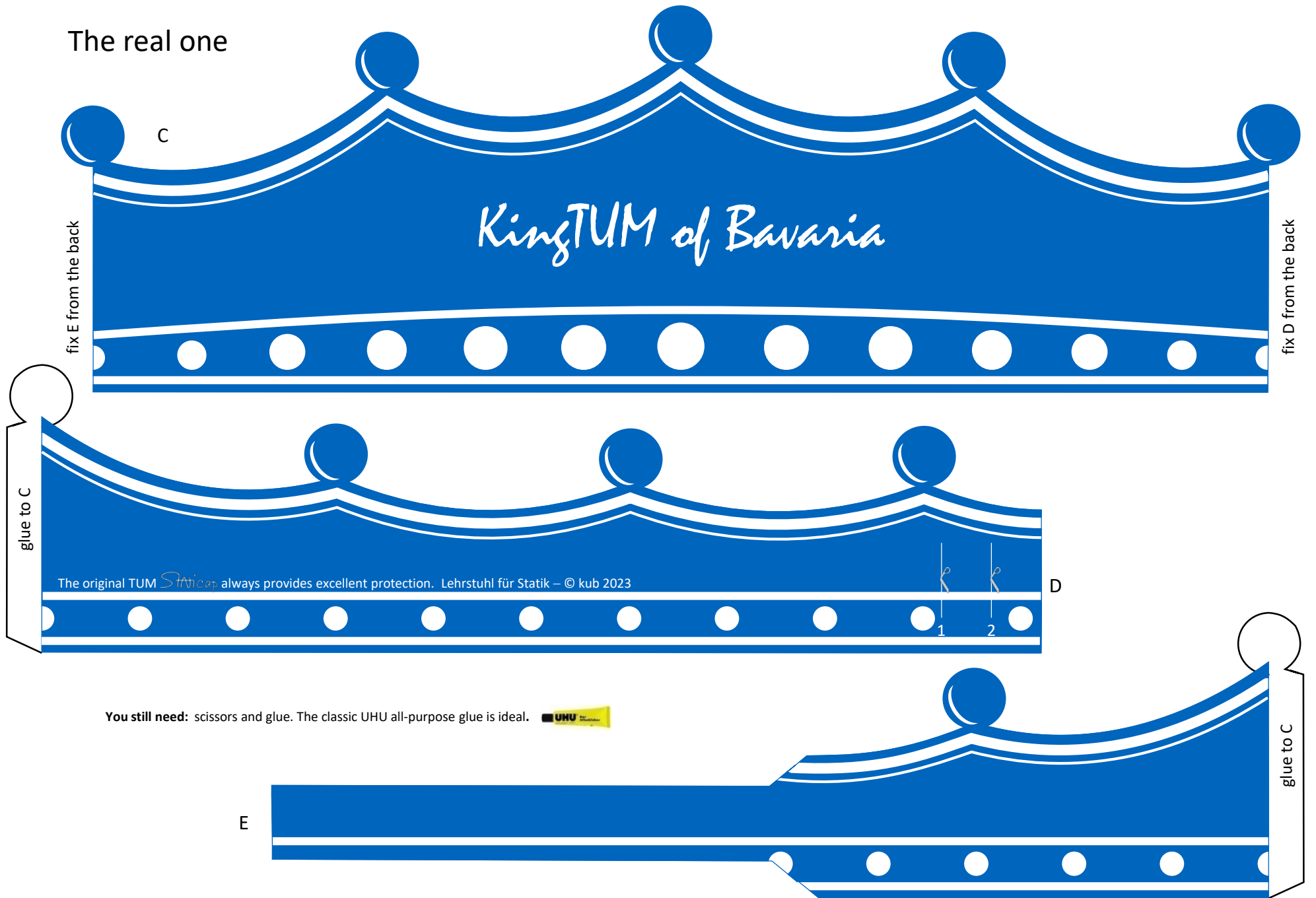

You still need: scissors and glue. The classic UHU all-purpose glue is ideal. 



Join the TUM family and wear the exclusive Christmas TUM *Staticap!* one size fits all ...

With all the best wishes for Christmas 2023 and the new year 2024. Stay save.

Your Lehrstuhl für Statik.

And this is how it works:

1. Cut out all parts A-E.
2. Part B: Cut the flaps and fold them upwards.
3. Turn A upside down and glue it to B from below.
4. Glue D and E to C.
5. Glue the flaps of B to C from the inside.
6. Thread the narrow end of E through slot 1 of D.
7. Adjust the size to your head, fold the narrow end and put it back into slot 2 of D. Eventually glue the parts.
8. Click to watch the trailer: <https://youtu.be/15wZt5PESqE>

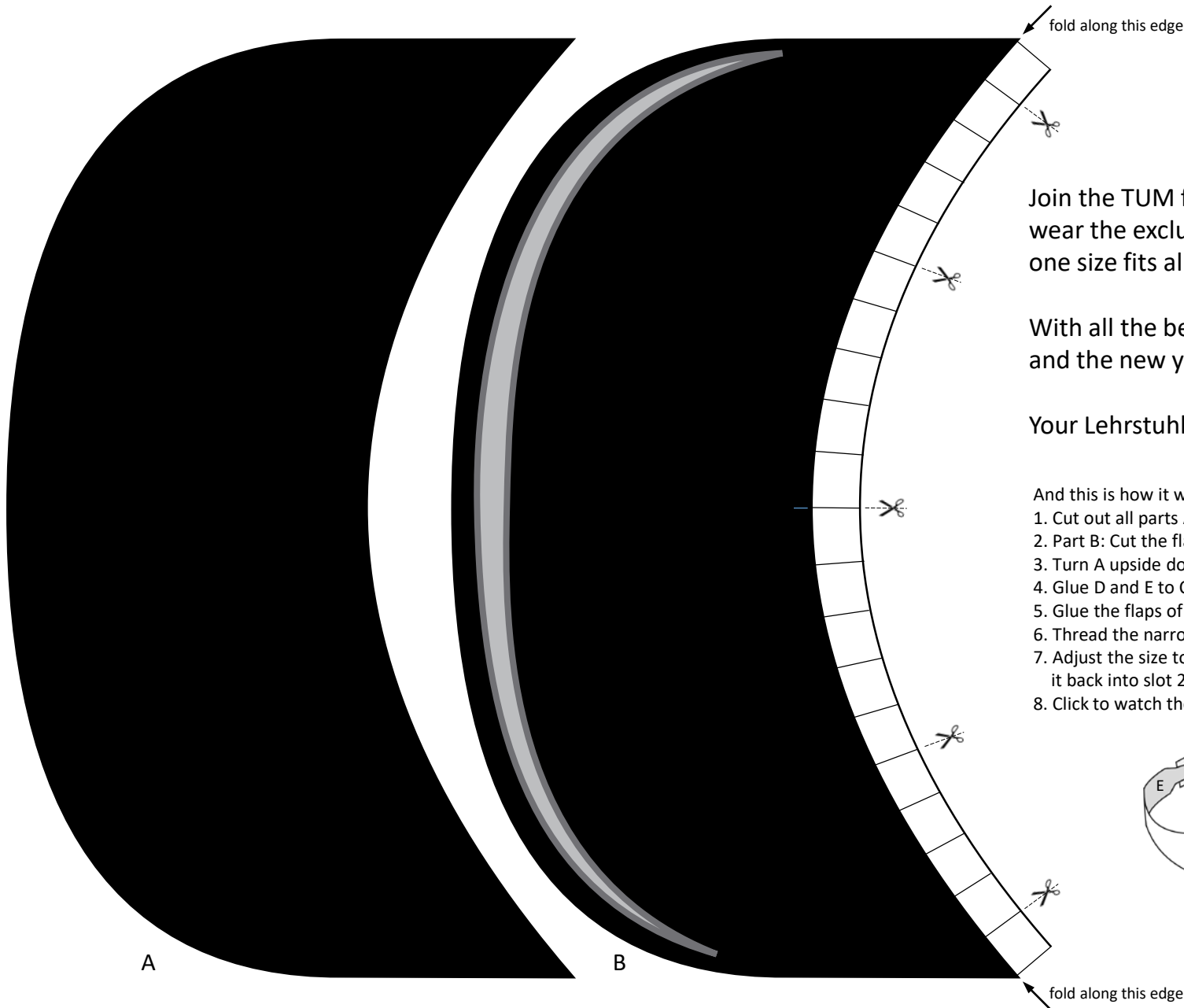
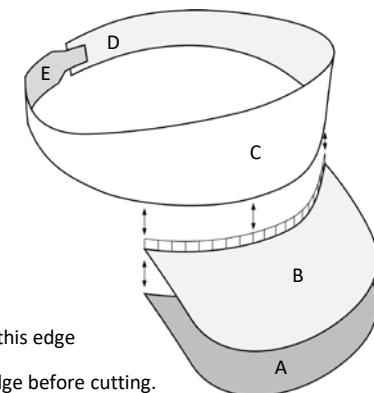

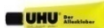
**You still need:** scissors and glue. The classic UHU all-purpose glue is ideal. 

**Hint:** Score the folded edge before cutting.



# Static silver iron special



C

fix E from the back



fix D from the back

glue to C

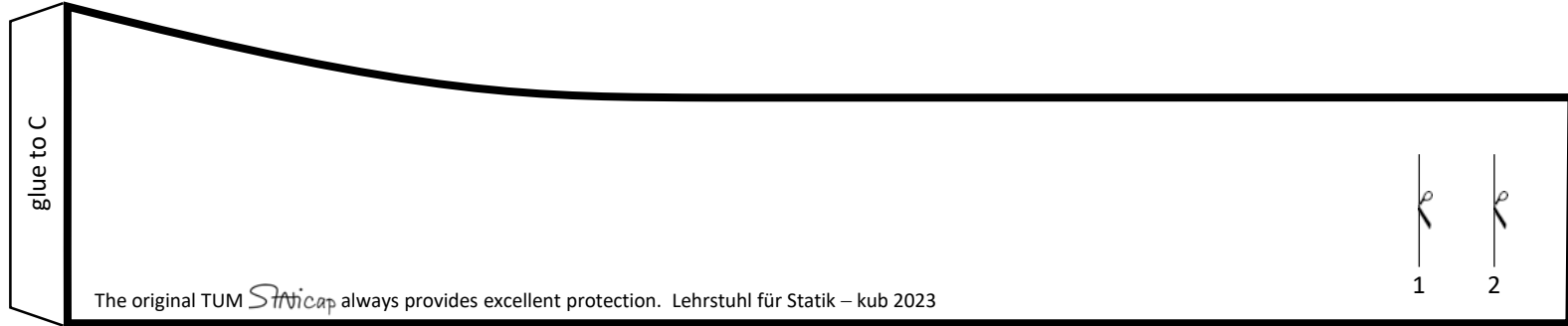

D

You still need: scissors and glue. The classic UHU all-purpose glue is ideal.



E

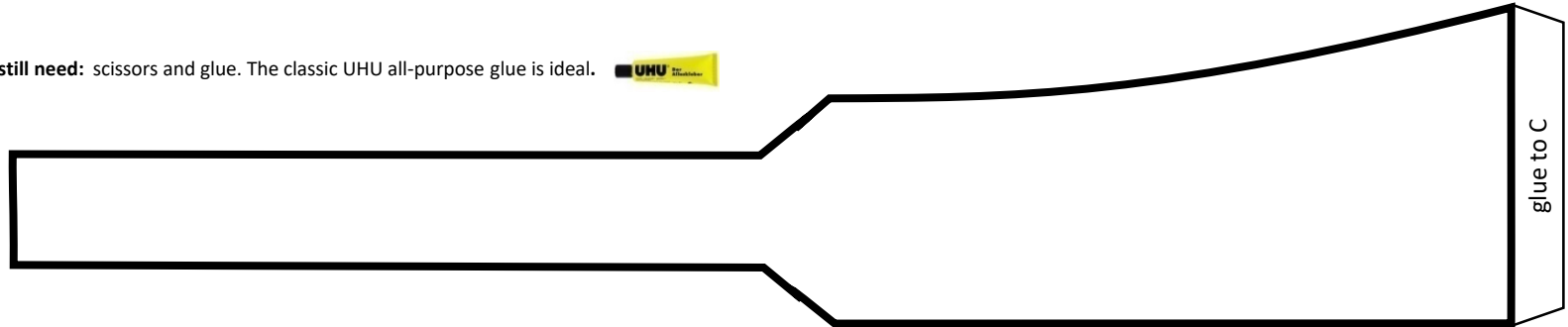

glue to C



Join the TUM family and wear the exclusive Christmas TUM *Staticap!* one size fits all ...

With all the best wishes for Christmas 2023 and the new year 2024. Stay save.

Your Lehrstuhl für Statik.

And this is how it works:

1. Cut out all parts A-E.
2. Part B: Cut the flaps and fold them upwards.
3. Turn A upside down and glue it to B from below.
4. Glue D and E to C.
5. Glue the flaps of B to C from the inside.
6. Thread the narrow end of E through slot 1 of D.
7. Adjust the size to your head, fold the narrow end and put it back into slot 2 of D. Eventually glue the parts.
8. Click to watch the trailer: <https://youtu.be/15wZt5PESqE>

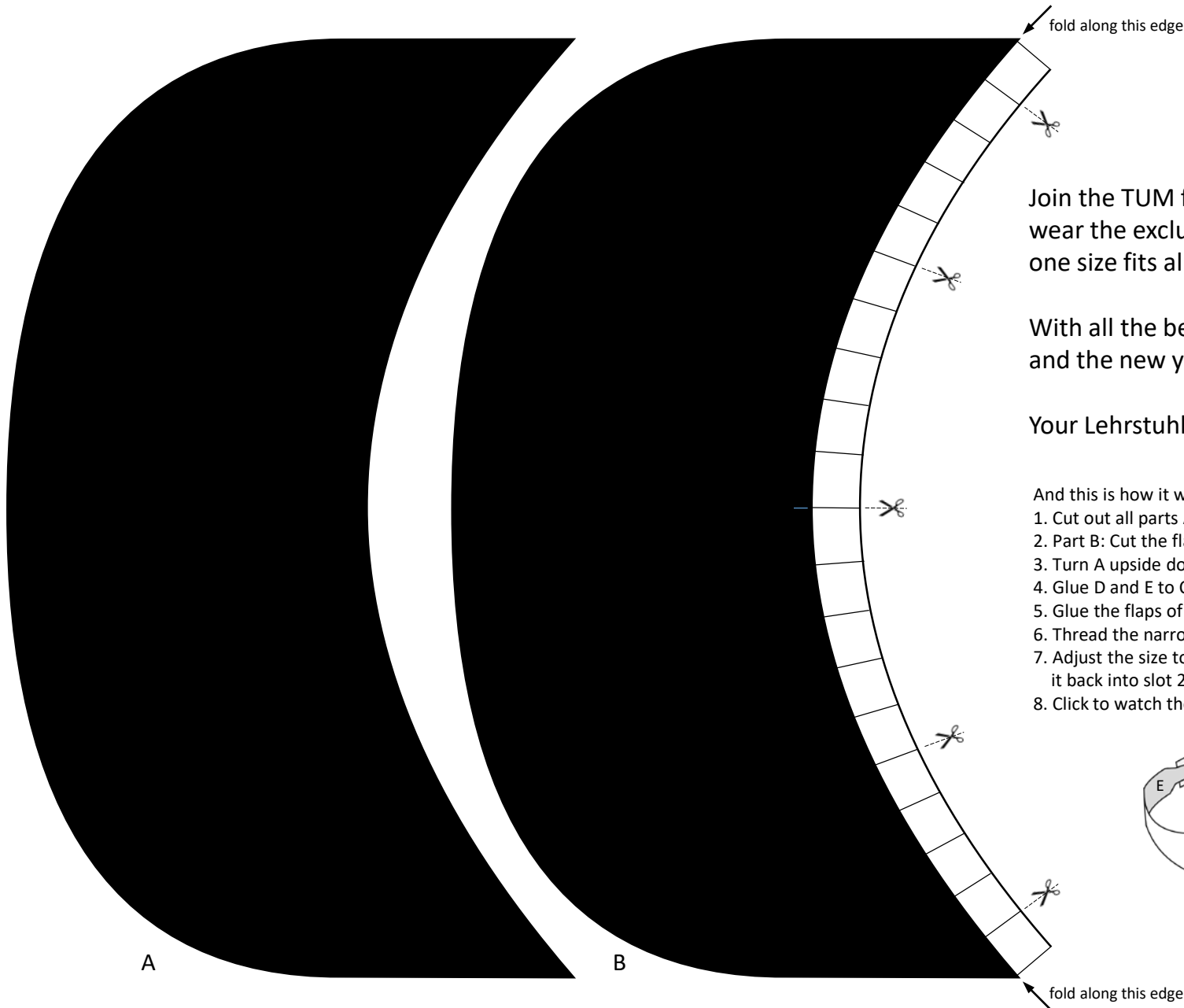
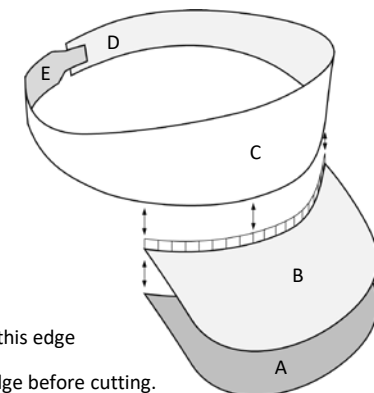

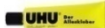
You still need: scissors and glue. The classic UHU all-purpose glue is ideal. 

Hint: Score the folded edge before cutting.



# Staller's blues



C

fix E from the back



fix D from the back



glue to C

D

You still need: scissors and glue. The classic UHU all-purpose glue is ideal.

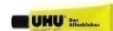

E



glue to C

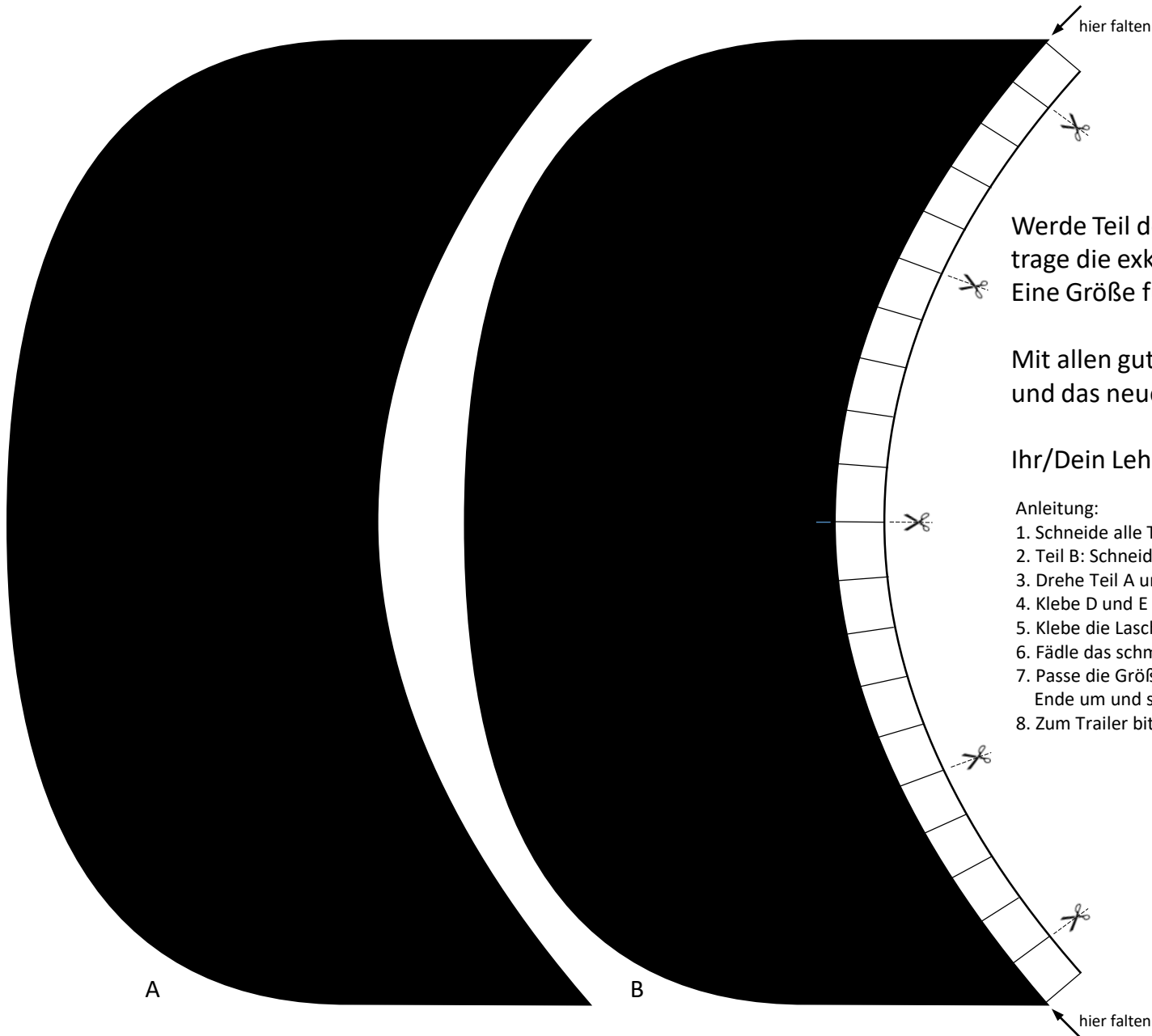

Werde Teil der TUM Familie und trage die exklusive Weihnachts-TUM-Staticap!  
Eine Größe für alle ...

Mit allen guten Wünschen für Weihnachten 2023 und das neue Jahr 2024. Bleibe behütet.

Ihr/Dein Lehrstuhl für Statik.

Anleitung:

1. Schneide alle Teile A-E aus.
2. Teil B: Schneide die Laschen ein und falte sie nach oben.
3. Drehe Teil A um und klebe es von unten auf B.
4. Klebe D und E an C.
5. Klebe die Laschen von B von innen an C.
6. Fädle das schmale Ende von E durch den Schlitz 1 von D.
7. Passe die Größe an deinen Kopf an, falte das schmale Ende um und stecke es zurück in Schlitz 2 von D.
8. Zum Trailer bitte klicken: <https://youtu.be/15wZt5PESqE>

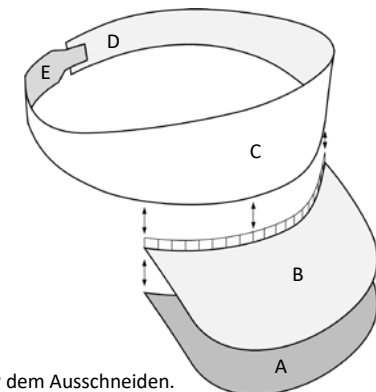





Luja-sog-i native



C

hier Teil E ankleben

# DIENSTMANN

hier Teil D ankleben



D

Du brauchst noch: Schere und Klebstoff. Der klassische UHU ist ideal. 

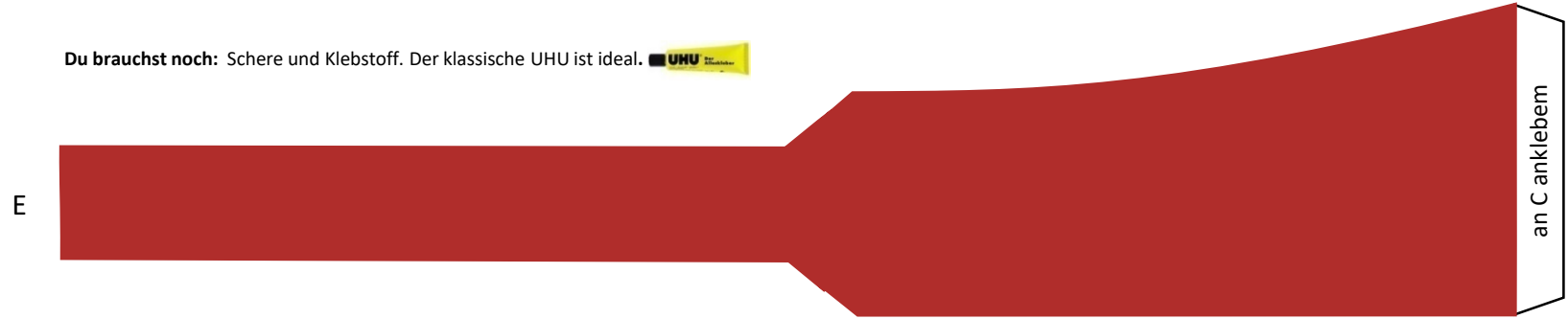

E



Join the TUM family and wear the exclusive Christmas TUM *Staticap!* one size fits all ...

With all the best wishes for Christmas 2023 and the new year 2024. Stay save.

Your Lehrstuhl für Statik.

And this is how it works:

1. Cut out all parts A-E.
2. Part B: Cut the flaps and fold them upwards.
3. Turn A upside down and glue it to B from below.
4. Glue D and E to C.
5. Glue the flaps of B to C from the inside.
6. Thread the narrow end of E through slot 1 of D.
7. Adjust the size to your head, fold the narrow end and put it back into slot 2 of D. Eventually glue the parts.
8. Click to watch the trailer: <https://youtu.be/15wZt5PESqE>

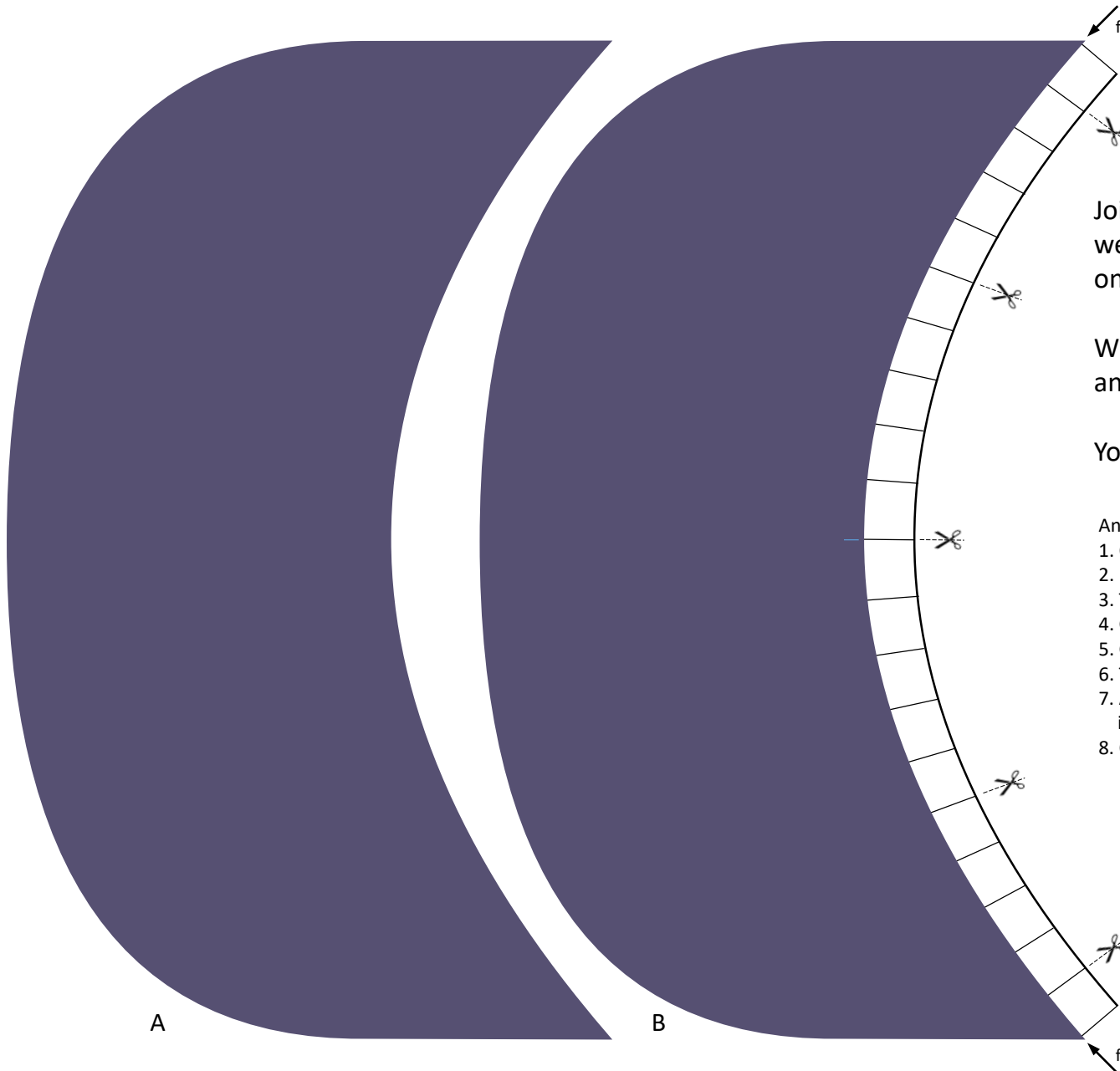
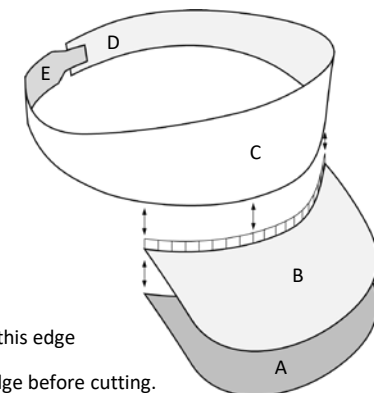

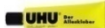
**You still need:** scissors and glue. The classic UHU all-purpose glue is ideal. 

**Hint:** Score the folded edge before cutting.



# Send me a dream

Who remembers  
Walter Spahrbier?



C  
fix E from the back

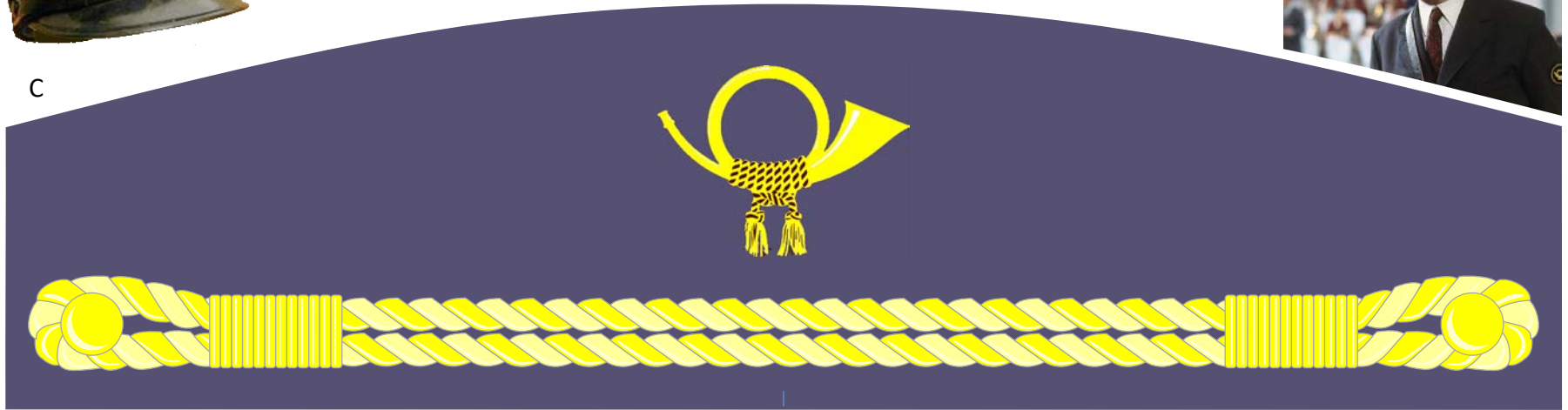

fix D from the back



**You still need:** scissors and glue. The classic UHU all-purpose glue is ideal.

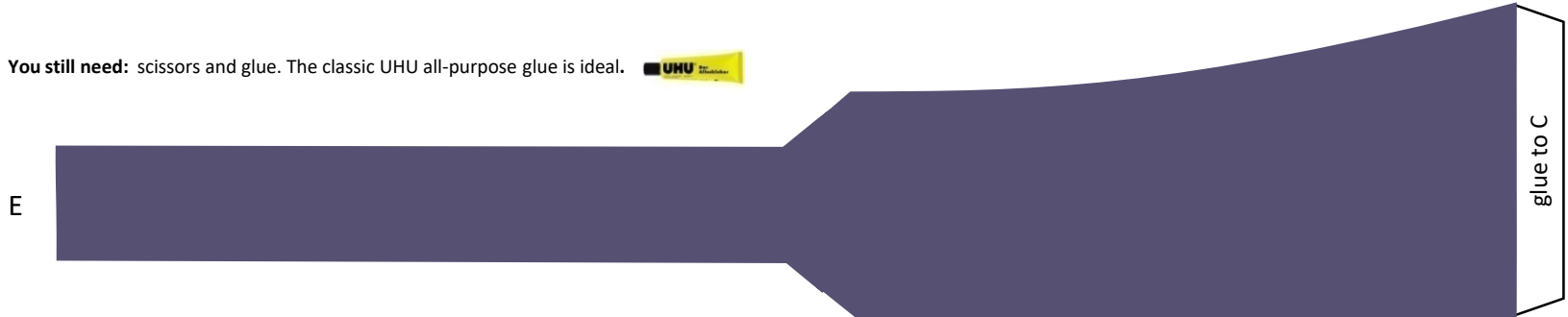

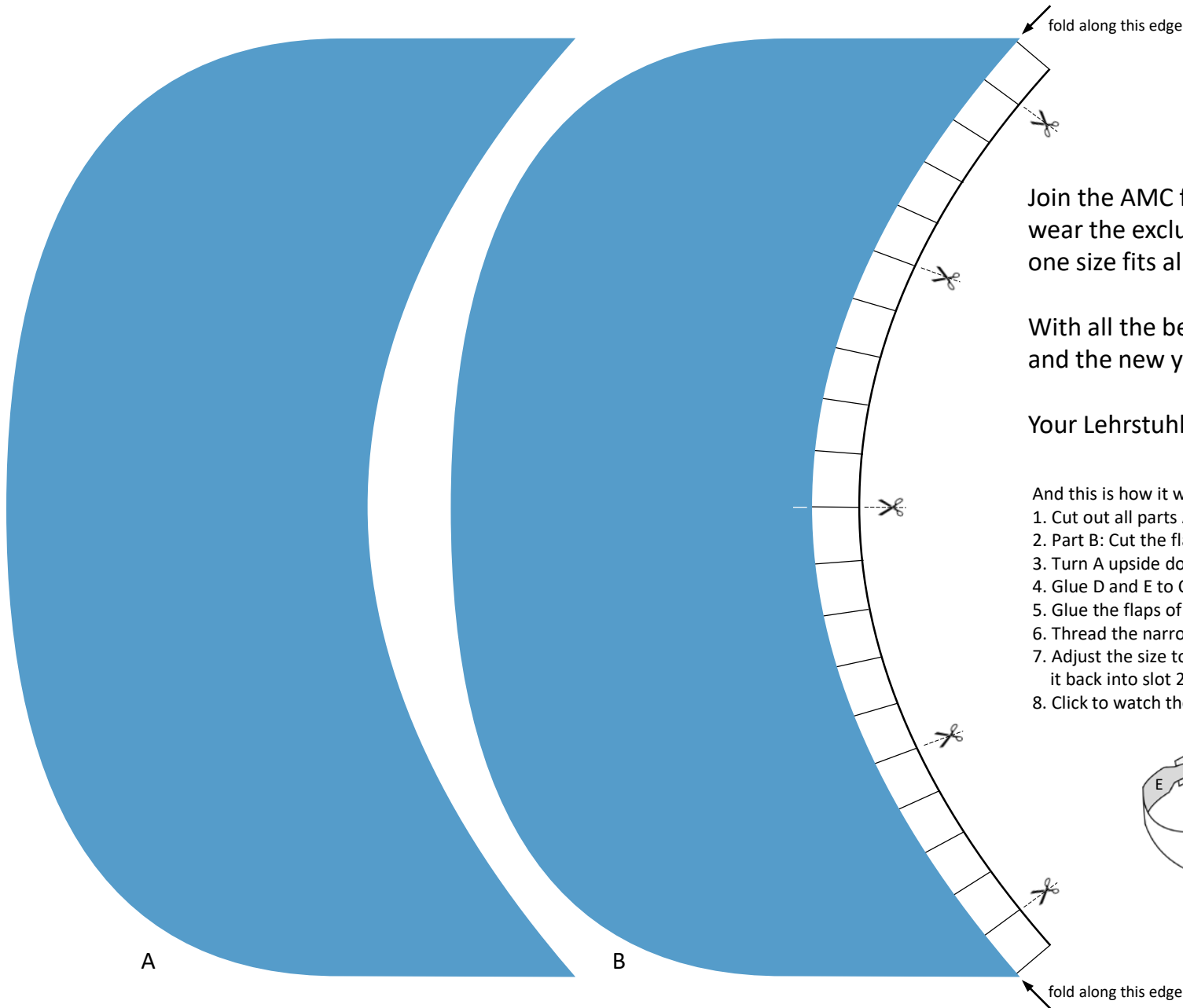

Join the AMC family and wear the exclusive AMC-*Stark*-Christmas cap! one size fits all ...

With all the best wishes for Christmas 2023 and the new year 2024. Stay save.

Your Lehrstuhl für Statik at TUM.

And this is how it works:

1. Cut out all parts A-E.
2. Part B: Cut the flaps and fold them upwards.
3. Turn A upside down and glue it to B from below.
4. Glue D and E to C.
5. Glue the flaps of B to C from the inside.
6. Thread the narrow end of E through slot 1 of D.
7. Adjust the size to your head, fold the narrow end and put it back into slot 2 of D. Eventually glue the parts.
8. Click to watch the trailer: <https://youtu.be/15wZt5PESqE>

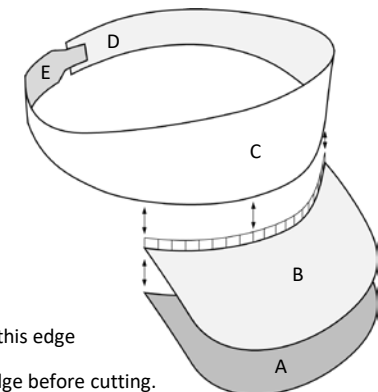

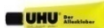
**You still need:** scissors and glue. The classic UHU all-purpose glue is ideal. 

**Hint:** Score the folded edge before cutting.

What is this?



**You still need:** scissors and glue. The classic UHU all-purpose glue is ideal.

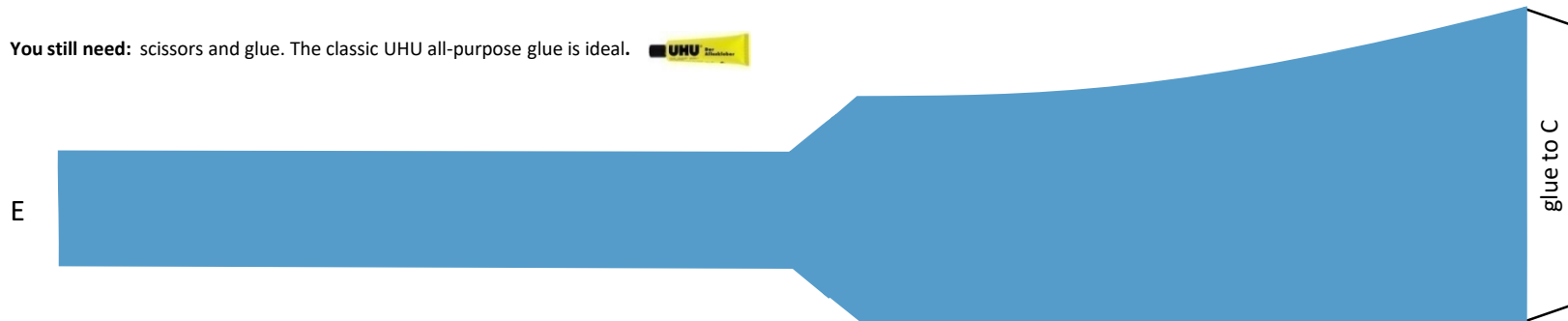



Join the TUM family and wear the exclusive Christmas TUM *Staticap!* one size fits all ...

With all the best wishes for Christmas 2023 and the new year 2024. Stay save.

Your Lehrstuhl für Statik.

And this is how it works:

1. Cut out all parts A-E.
2. Part B: Cut the flaps and fold them upwards.
3. Turn A upside down and glue it to B from below.
4. Glue D and E to C.
5. Glue the flaps of B to C from the inside.
6. Thread the narrow end of E through slot 1 of D.
7. Adjust the size to your head, fold the narrow end and put it back into slot 2 of D. Eventually glue the parts.
8. Click to watch the trailer: <https://youtu.be/15wZt5PESqE>

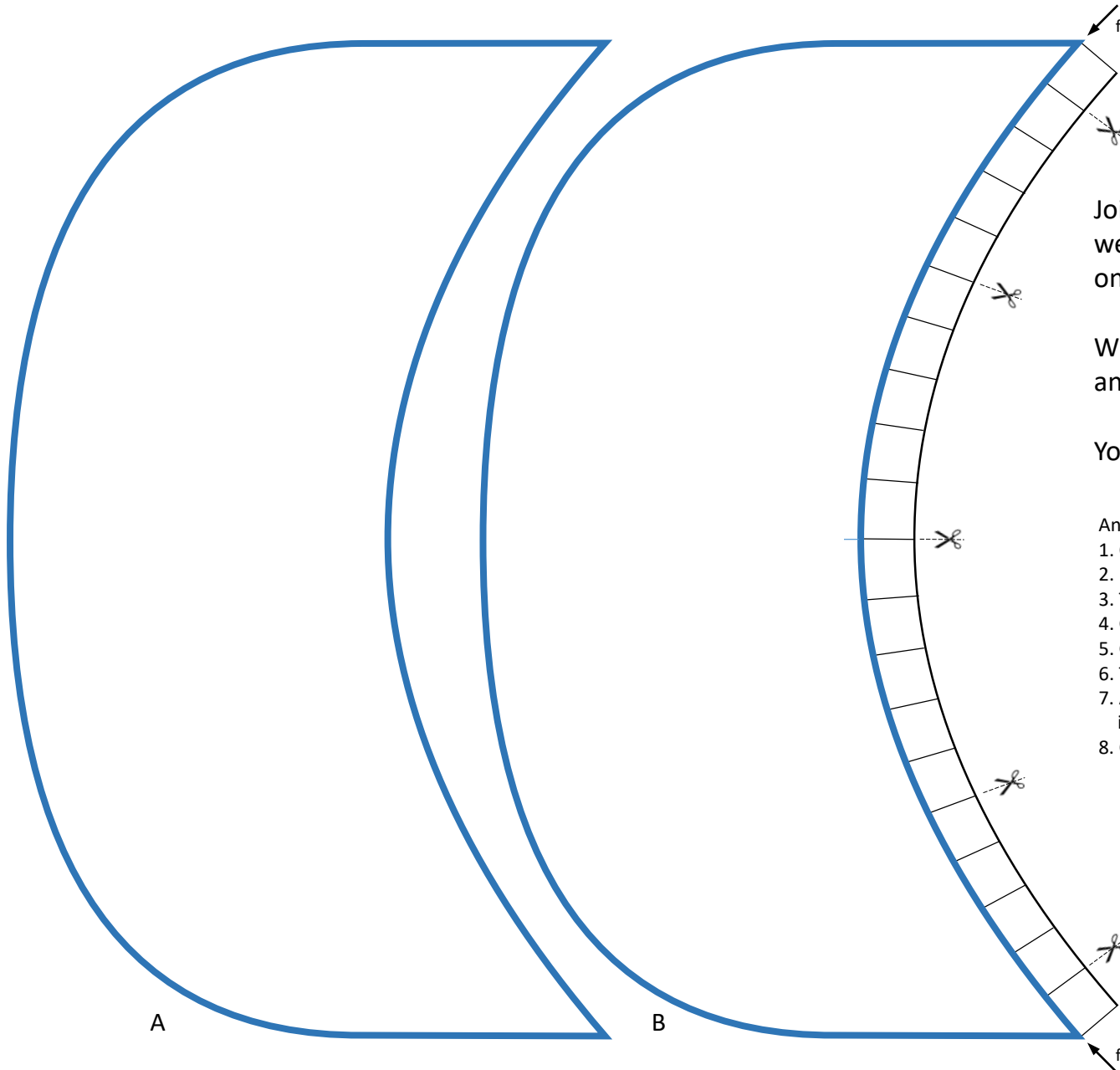
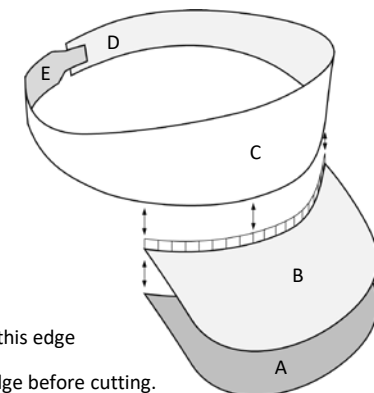

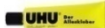
**You still need:** scissors and glue. The classic UHU all-purpose glue is ideal. 

**Hint:** Score the folded edge before cutting.

# Design your individual cap

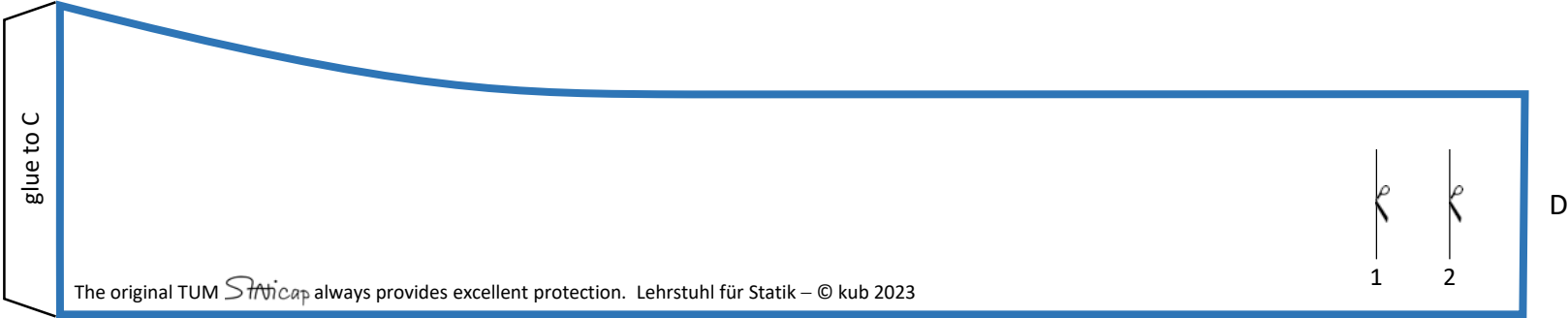
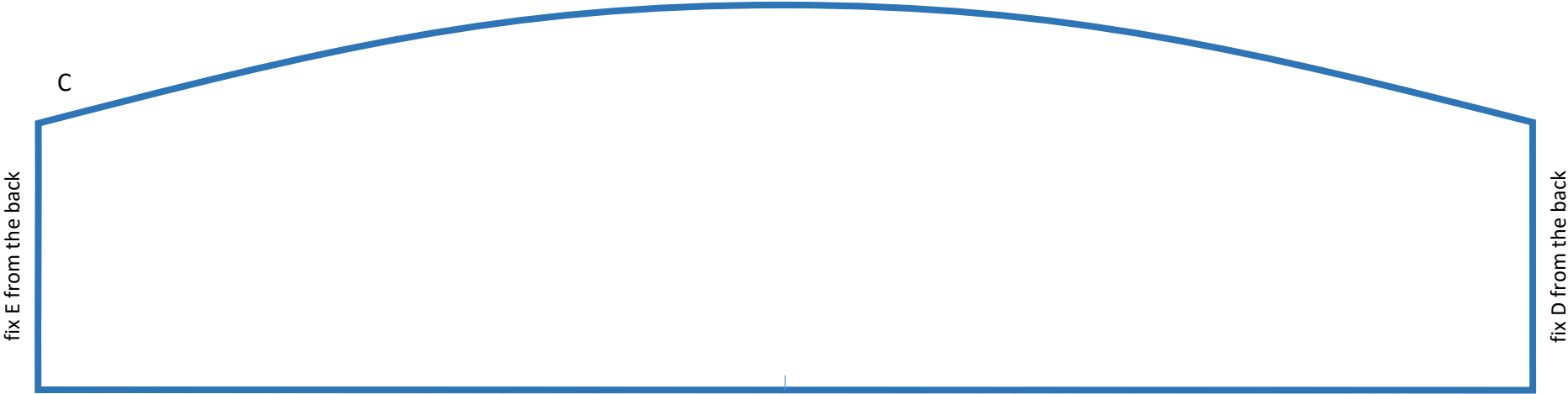

**You still need:** scissors and glue. The classic UHU all-purpose glue is ideal.

